

# TMD Universality

P.J. Mulders

Nikhef and VU University, Amsterdam

The basic idea of PDFs is achieving a factorized description with soft and hard parts, soft parts being portable and hard parts being calculable. In the leading contributions at high energies, the PDFs can be interpreted as probabilities. Beyond the collinear treatment one considers not only the dependence on parton momentum fractions  $x$ , but also the dependence on the transverse momentum  $p_T$  of the partons. Experimentally, transverse momentum dependent functions (TMDs) provide a rich phenomenology of azimuthal asymmetries for produced hadrons or jet-jet asymmetries. Furthermore inclusion of transverse momentum dependence provides an explanation for single spin asymmetries.

An important issue is the universality of TMDs, which we study for some characteristic hard processes, where we focus on the peculiarities coming from the color flow in the hard part. This color flow in the hard process gives rise to a variety of Wilson lines in the description of the cross section. These give rise to color entanglement, in particular in situations that the color flow is not just a simple transfer of color from initial or final state.

We argue that these Wilson lines can be combined into the appropriate gauge links for TMD correlators in cases where only the transverse momentum of partons in a single (incoming) hadron is relevant (1-parton un-integrated or 1PU processes). Such a situation occurs in single weighted cross sections, which consists of a sum of 1PU processes or if absence of any polarization makes all explicit transverse momentum effects vanish. For 1PU processes one finds TMDs with a complex gauge link structure depending on the color flow of the hard process. In the case of single weighted cross sections the results are the gluonic pole or Qiu-Sterman matrix elements appearing with calculable color factors.

I acknowledge discussions with Maarten Buřfing (VU), Ted Rogers (VU) and Mert Aybat (VU and Nikhef). This research is part of the research programme of the Foundation for Fundamental Research of Matter and the National Organisation for Scientific Research (NOW). It is also part of the FP7 EU programme Hadron Physics (No 227431).

Summary of talk given at the Workshop on Opportunities for DY at RHIC, Brookhaven National Laboratory, May 11-13, 2001



## Introduction

- Isolating hard process (factorization)
  - Study of quark and gluon structure of hadrons
  - Account for hadronic physics to study hard process
- Beyond collinear approach
  - Include mismatch of parton momentum p and xP (fraction of hadron momentum)
- TMDs with novel features
  - Operator structure of TMDs
  - Color gauge invariance as guiding principle
  - Appearance of TMDs in hard processes
  - Gauge links in 1-particle un-integrated (1PU) processes

1



## PDFs and PFFs

Basic idea of PDFs is to get a full factorized description of high energy scattering processes

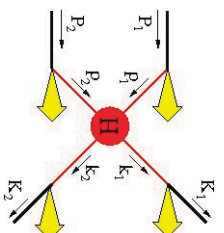

$$\hat{\sigma} = |H(p_1, p_2, \dots)|^2$$

calculable

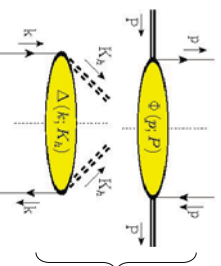

defined (i) & portable

$$\sigma(P_1, P_2, \dots) = \iiint \dots dp_1 \dots \Phi_a(P_1, P_1; \mu) \otimes \Phi_b(P_2, P_2; \mu)$$

Give a meaning to integration variables!

$$\otimes \hat{\sigma}_{\text{obs}, \dots}(p_1, p_2, \dots; \mu) \otimes \Delta_c(k_1, K_1; \mu) \dots$$



## Example: Drell-Yan process

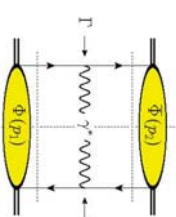

$$\sum_s u(p_1, s) \bar{u}(p_2, s) \Rightarrow \Phi(p_1, P) \sim (p_1 + m) f(p_1)$$

- High energy limits number of soft matrix elements that contribute (twist expansion),
- Expand parton momenta (for DY take e.g.  $n = P_2/P_1, P_2$ )
 
$$p = x P^+ + P_T^+ + \sigma n^+ \quad \begin{matrix} x = p^+ = p \cdot n \sim 1 \\ \sim Q \quad \sim M \quad \sim M^2/Q \end{matrix}$$

$$\sigma = p \cdot P - x M^2 \sim M^2$$
- For meaningful separation of hard and soft, integrate over  $p, P$  and look at  $\Phi(x, P_T)$ . This shows that separation fails beyond 'twist 3'.

3



## Integrated quark correlators: collinear and TMD

- Rather than considering general correlator  $\Phi(p, P, \dots)$ , one integrates over  $p, P = p^- (\sim M_{R^2})$ , which is of order  $M^2$

$$\Phi_B^q(x, P_T; n) = \int \frac{d(\xi, P)}{(2\pi)^3} d^2 \xi_{\perp} e^{i p \cdot \xi} \langle P | \bar{\psi}_j(0) \psi_j(\xi) | P \rangle_{\xi \cdot n = 0}$$

TMD  
lightfront

- and/or  $P_T$  (which is of order 1)

$$\Phi_B^q(x; n) = \int \frac{d(\xi, P)}{(2\pi)^2} e^{i p \cdot \xi} \langle P | \bar{\psi}_j(0) \psi_j(\xi) | P \rangle_{\xi \cdot n = 0}$$

collinear  
lightcone

- The integration over  $p^- = p \cdot P$  makes time-ordering automatic. This works for  $\Phi(x)$  and  $\Phi(x, P_T)$
- This allows the interpretation of soft (squared) matrix elements as forward antiquark-target amplitudes (untruncated!), which satisfy particular analyticity and support properties, etc.

4



## Relevance of transverse momenta?

- At high energies fractional parton momenta fixed by kinematics (external momenta)

$$p_1 \approx x_1 P_1 + P_{1T}$$

$$p_2 \approx x_2 P_2 + P_{2T}$$

$$DY \quad x_1 = p_1 \cdot n = \frac{P_1 \cdot P_2}{P_1 \cdot P_2} = \frac{q \cdot P_2}{P_1 \cdot P_2}$$

- Also possible for transverse momenta of partons

$$DY \quad q_T = q - x_1 P_1 - x_2 P_2 = P_{1T} + P_{2T}$$

2-particle inclusive hadron-hadron scattering

$$q_T = z_1^{-1} K_1 + z_2^{-1} K_2 - x_1 P_1 - x_2 P_2$$

$$= P_{1T} + P_{2T} - k_{1T} - k_{2T}$$

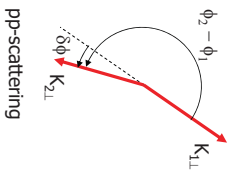

Care is needed: we need more than one hadron and knowledge of hard process(es)!

Second scale!

## Opportunities of TMDs



- TMD quark correlators (leading part, unpolarized) including T-odd part

$$\Phi^{[\pm]q}(x, p_T) = \left( f_1^q(x, p_T^2) \pm i h_{1T}^{\perp q}(x, p_T^2) \frac{p_T^\perp}{M} \right) \frac{p^\perp}{2}$$

- Interpretation: quark momentum distribution  $f_1^q(x, p_T)$  and its transverse spin polarization  $h_{1T}^{\perp q}(x, p_T)$  both in an unpolarized hadron
- The function  $h_{1T}^{\perp q}(x, p_T)$  is T-odd (momentum-spin correlations)
- TMD gluon correlators (leading part, unpolarized)

$$\Phi_g^{uv}(x, p_T) = \frac{1}{2x} \left( -g_T^{uv} f_1^g(x, p_T^2) + \left( \frac{p_T^u p_T^v + \frac{1}{2} g_T^{uv}}{M^2} \right) h_{1T}^{Tg}(x, p_T^2) \right)$$

- Interpretation: gluon momentum distribution  $f_1^g(x, p_T)$  and its linear polarization  $h_{1T}^{\perp g}(x, p_T)$  in an unpolarized hadron (both are T-even)



## Twist expansion of (non-local) correlators

- Dimensional analysis to determine importance of matrix elements (just as for local operators)
- maximize contractions with  $n$  to get leading contributions

$$\dim[\bar{\psi}(0) \not{n} \psi(\xi)] = 2$$

$$\dim[F^{uv}(0) F^{uv}(\xi)] = 2$$

- Good' fermion fields and 'transverse' gauge fields and in addition any number of  $n \cdot A(\xi) = A^\alpha(x)$  fields (dimension zero!) but in color gauge invariant combinations

$$\dim 0: \quad i\partial^n \rightarrow iD^n = i\partial^n + gA^n$$

$$\dim 1: \quad i\partial_T^\alpha \rightarrow iD_T^\alpha = i\partial_T^\alpha + gA_T^\alpha$$

- Transverse momentum involves 'twist 3'.

## Gauge link results from leading gluons

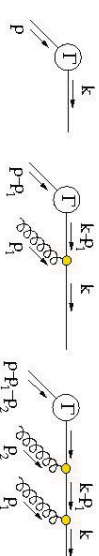

Expand gluon fields and reshuffle a bit:

$$A^\mu(p) = n \cdot A(p) \frac{p^\mu}{n \cdot P} + i A_T^\mu(p) + \dots = \frac{1}{p_1 \cdot n} [A^\mu(p) p^\mu + i C_T^\mu(p) + \dots]$$

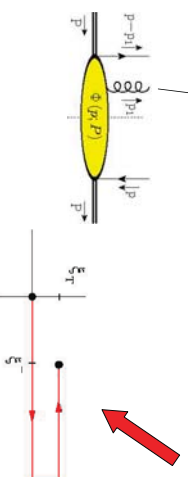

Coupling only to final state partons, the collinear gluons add up to a  $U_c$  gauge link, (with transverse connection from  $A_T^\alpha \rightarrow G^{uv}$  reshuffling)



## Gauge-invariant definition of TMDs: which gauge links?

$$\Phi_{ij}^{q[C]}(x, p_T; n) = \int \frac{d(\xi, P)}{(2\pi)^3} d^2\xi_T e^{ip \cdot \xi} \langle P | \bar{\psi}(0) U_{[0, \xi]}^{[C]} \psi(\xi) | P \rangle_{\xi, n=0}$$

TMD

$$\Phi_g^q(x; n) = \int \frac{d(\xi, P)}{(2\pi)^2} e^{ip \cdot \xi} \langle P | \bar{\psi}(0) U_{[0, \xi]}^{[C]} \psi(\xi) | P \rangle_{\xi, n=0}$$

collinear

- Even simplest links for TMD correlators non-trivial:

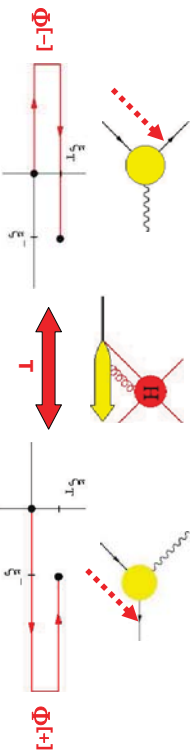

These merge into a 'simple' Wilson line in collinear (P<sub>T</sub>-integrated) case

OPERATOR STRUCTURE



## Featuring: phases in gauge theories

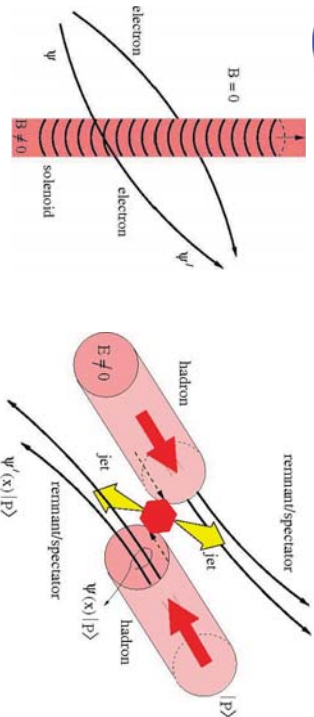

$$\psi' = P e^{ie \int_{0, \xi}^{\xi} A} \psi$$

$$\psi_i(x) |P\rangle = P e^{-ie \int_{0, \xi}^{\xi} d\mu_i A^{\mu}} \psi_i(x') |P\rangle$$

COLOR ENTANGLEMENT



## TMD correlators: gluons

C Bomhof, PJM, F Pilman: EPJ C 47 (2006) 147  
F Dominguez, B-W Xiao, F Yuan, PRL 106 (2011) 022301

$$\Phi_g^{q[C]}(x, p_T; n) = \int \frac{d(\xi, P)}{(2\pi)^3} d^2\xi_T e^{ip \cdot \xi} \langle P | U_{[\xi, 0]}^{[C]} F^{n\alpha}(0) U_{[0, \xi]}^{[C]} F^{n\beta}(\xi) | P \rangle_{\xi, n=0}$$

- The most general TMD gluon correlator contains two links, which in general can have different paths.

- Note that standard field displacement involves  $C = C'$

$$F^{n\alpha\beta}(\xi) \rightarrow U_{[n, \xi]}^{[C]} F^{n\alpha\beta}(\xi) U_{[\xi, n]}^{[C]}$$

- Basic (simplest) gauge links for gluon TMD correlators:

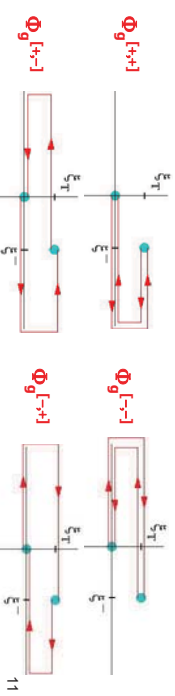

OPERATOR STRUCTURE



## Gauge invariance for DY

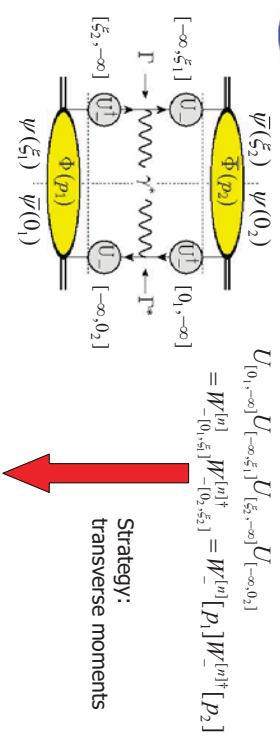

$$d\sigma_{DY} = Tr_c [W_{[-\infty, 1]}^\dagger [P_1] \Phi_q(x_1, p_{T1})] Tr_c [\Phi_q(x_2, p_{T2}) W_{[-\infty, 1]}^\dagger [P_2]] \perp \Gamma^{\mu\nu} = \Phi_q^{(-)}(x_1, p_{T1}) \Phi_q^{(-\dagger)}(x_2, p_{T2}) \hat{\sigma}_{\mu\nu \rightarrow \gamma}$$

Employing simple color flow possibilities, e.g. in gg  $\rightarrow \gamma\gamma$   
J. Qiu, M. Schlegel, W. Vogelsang, ArXiv 1103.3861 (hep-ph)

COLOR ENTANGLEMENT

## Complications (example: qq → qq)

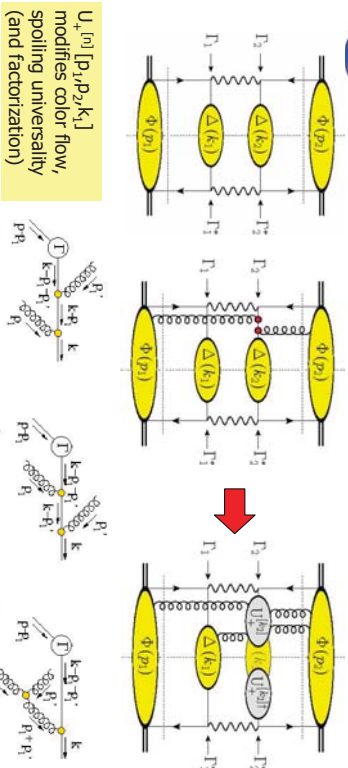

$U_{+}^{[n]}[p_1, p_2, k_1]$   
modifies color flow,  
spoiling universality  
(and factorization)

$$U_{+}^{[k_1^{(1)}]}(p, p') \dots \Gamma \dots \psi(p) \dots \psi(p') = \frac{1}{2} \left\{ U_{+}^{[k_1^{(1)}]}(p), U_{+}^{[k_1^{(1)}]}(p') \right\} \dots \Gamma \dots \psi(p) \dots \psi(p')$$

COLOR ENTANGLEMENT

M.G.A. Buffing, PJM, in preparation

## Color disentanglement for 1PU

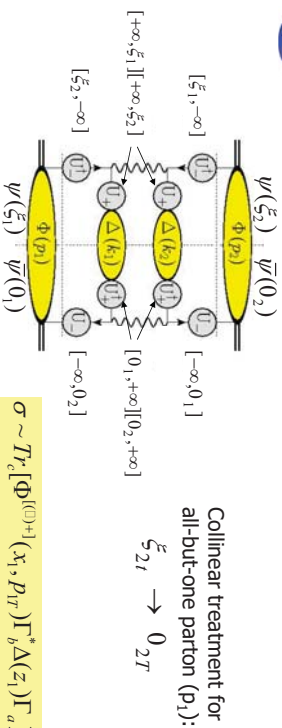

Collinear treatment for  
all-but-one parton (p<sub>1</sub>):

$$\xi_{2T} \rightarrow 0_{2T}$$

$$\sigma \sim Tr_c [\Phi^{(0)+1}(x_1, p_T) \Gamma_b^* \Delta(z_1) \Gamma_a] \times Tr_c [\Phi(x_2) \Gamma^{b*} \Delta(z_2) \Gamma^a]$$

$$U_{[0_2, +\infty][0_1, +\infty]} U_{[+\infty, \xi_2][+\infty, \xi_1]} U_{[\xi_1, -\infty]} U_{[-\infty, 0_1]} = W_{[0_2, +\infty]}^{[n]} W_{[0_1, +\infty]}^{[n]} W_{[\xi_1, -\infty]}^{[n]} W_{[-\infty, 0_1]}^{[n]} = W_{[0_2, +\infty]}^{[n]} W_{[0_1, +\infty]}^{[n]} W_{[\xi_2, -\infty]}^{[n]} W_{[-\infty, 0_2]}^{[n]} = W_{[0_1, +\infty]}^{[n]} U_{[\xi_2, -\infty]}^{[n]} U_{[-\infty, 0_2]}^{[n]} = W_{[0_1, \xi_1]}^{[n]} W_{[-\infty, 0_2]}^{[n]} = W_{[0_1, \xi_1]}^{[n]}$$

COLOR ENTANGLEMENT

## 1-parton unintegrated

- Resummation of all phases spoils universality
- Transverse moments (p<sub>T</sub>-weighting) feels entanglement
- Special situations for only **one** transverse momentum, as in single weighted asymmetries

$$\int d^2 q_T q_T^a \dots \int d^2 p_T \int d^2 p_T \dots \delta^2(q_T - p_T - p_T) = \int d^2 p_T p_T^a \int d^2 p_{2T} \dots + \int d^2 p_T \int d^2 p_{2T} p_{2T}^a \dots$$

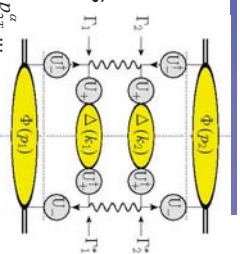

- But: it does produces 'complex' gauge links
- Applications of 1PU is looking for gluon h<sub>1,0</sub> (linear gluon polarization) using jet or heavy quark production in ep scattering (e.g. EIC), D. Boer, S.J. Brodsky, PJM, C. Pisano, PRL 106 (2011) 132001

15

COLOR ENTANGLEMENT

M.G.A. Buffing, PJM, in preparation

## Full color disentanglement? NO!

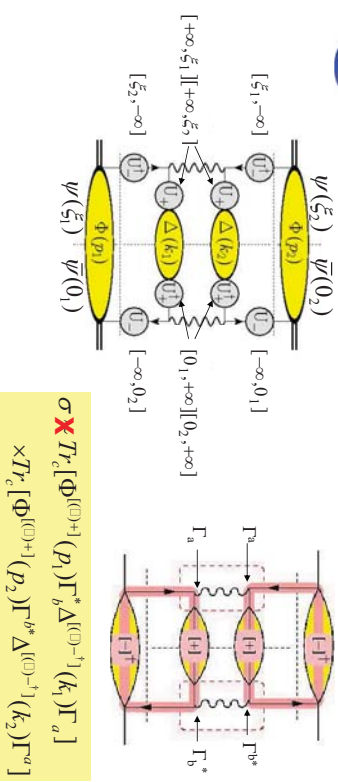

$$\sigma \times Tr_c [\Phi^{(0)+1}(p_1) \Gamma_b^* \Delta^{(0)-1}(k_1) \Gamma_a] \times Tr_c [\Phi^{(0)+1}(p_2) \Gamma^{b*} \Delta^{(0)-1}(k_2) \Gamma^a]$$

$$\text{Loop 1: } U_{[0_2, +\infty][0_1, +\infty]} U_{[+\infty, \xi_2][+\infty, \xi_1]} U_{[\xi_1, -\infty]} U_{[-\infty, 0_1]} = W_{[0_2, +\infty]}^{[n]} W_{[0_1, +\infty]}^{[n]} W_{[\xi_1, -\infty]}^{[n]} W_{[-\infty, 0_1]}^{[n]} = W_{[0_2, +\infty]}^{[n]} W_{[0_1, +\infty]}^{[n]} W_{[\xi_2, -\infty]}^{[n]} W_{[-\infty, 0_2]}^{[n]} = W_{[0_1, \xi_1]}^{[n]} W_{[-\infty, 0_2]}^{[n]} = W_{[0_1, \xi_1]}^{[n]}$$

COLOR ENTANGLEMENT

16



## Result for integrated cross section

$$\frac{d\sigma}{d^2 p_T} \sim \sum_{D,abc} \Phi_a^{[C(D)]}(x_1, p_T) \Phi_b(x_2) \hat{\sigma}_{ab \rightarrow c \dots}^{[D]} \Delta_c(z_1) \dots \quad (1PU)$$

Collinear cross section

$$\Phi_X^{[1]}(x) = \int d^2 p_T \Phi^{[C]}(x, p_T)$$

Gauge link structure becomes irrelevant!

$$\sigma \sim \sum_{abc} \Phi_a(x_1) \Phi_b(x_2) \hat{\sigma}_{ab \rightarrow c \dots} \Delta_c(z_1) \dots$$

$$\hat{\sigma}_{ab \rightarrow c \dots} = \sum_D \hat{\sigma}_{ab \rightarrow c \dots}^{[D]} \quad (\text{partonic cross section})$$

APPLICATIONS

17



## Result for single weighted cross section

$$\frac{d\sigma}{d^2 p_T} \sim \sum_{D,abc} \Phi_a^{[C(D)]}(x_1, p_T) \Phi_b(x_2) \hat{\sigma}_{ab \rightarrow c \dots}^{[D]} \Delta_c(z_1) \dots \quad (1PU)$$

$$\langle p_T^\alpha \sigma \rangle \sim \sum_{D,abc} \Phi_a^{[C(D)]}(x_1) \Phi_b(x_2) \hat{\sigma}_{ab \rightarrow c \dots}^{[D]} \Delta_c(z_1) \dots$$

$$\Phi_a^{[C]}(x) = \tilde{\Phi}_a^{[X]}(x) + C_G^{[U(C)]} \pi \Phi_G^{[X]}(x, x)$$

$$\langle p_T^\alpha \sigma \rangle \sim \sum_{abc} \tilde{\Phi}_a^\alpha(x_1) \Phi_b(x_2) \hat{\sigma}_{ab \rightarrow c \dots} \Delta_c(z_1) \dots$$

$\Phi_G(X, X)$  is gluonic pole ( $X_1 = 0$ ) matrix element

$$+ \sum_{abc} \pi \Phi_{G,a}^\alpha(x_1, x_1) \Phi_b(x_2) \hat{\sigma}_{[ab] \rightarrow c \dots} \Delta_c(z_1) \dots$$

T-odd part

$$\hat{\sigma}_{[a]b \rightarrow c \dots} = \sum_D C_G^{[U(C(D))]} \hat{\sigma}_{ab \rightarrow c \dots}^{[D]} \quad (\text{gluonic pole cross section})$$

APPLICATIONS

18



## Higher $p_T$ moments

- Higher transverse moments

$$\Phi_{[N]q_1 \dots q_N}^{[X]}(x) = \int d^2 p_T (p_T^{q_1} \dots p_T^{q_N} - \text{traces}) \Phi(x, p_T)$$

- Involve yet more functions

$$\tilde{\Phi}_{20}^{\alpha\beta}(x), \tilde{\Phi}_{2G}^{\alpha\beta}(x, x), \Phi_{GG}^{\alpha\beta}(x, x, x)$$

- Important application: there are no complications for fragmentation, since the 'extra' functions  $\Delta_{G^*} \Delta_{G^*} \dots$  vanish. using the link to amplitudes,

L. Gamberg, A. Mukherjee, PRL 103 (2011) 071503 (R)

- In general, by looking at higher transverse moments at tree-level, one concludes that transverse momentum effects from different initial state hadrons cannot simply factorize.

APPLICATIONS

19



## Conclusions

- Color gauge invariance produces a jungle of Wilson lines attached to all parton legs, although the gauge connections themselves have a nicely symmetrized form
- Easy cases are **collinear** and **1-parton un-integrated (1PU)** processes, with in the latter case for the TMD a complex gauge link, depending on the color flow in the tree-level hard process
- Example of 1PU processes are the terms in the sum of contributions to single weighted cross sections
- Single weighted cross sections involve T-even 'normal weighting' and T-odd gluonic pole matrix elements (SSAs)
- Gluonic pole matrix elements in fragmentation correlators vanish, thus treatment of fragmentation TMDs is universal (physical picture: observation of jet direction)
- Furthermore, there is the issue of factorization! (talk Ted Rogers)

SUMMARY

20